

RACCORDI E INNESTI PER RAFFREDDAMENTO STANDARD EUROPEO

COUPLERS FOR MOULD COOLING EUROPEAN STANDARD

CODICE / Item no.

TL..

S	SERIES			A	D	L	L1	SW	VPE
6	65	TL6510	TL6510OV	10	18	52	22		10
9	90	TL9013	TL9013OV	13	23	61,5	25		10
13	20	TL2019	TL2019OV	19	32	90	32		5

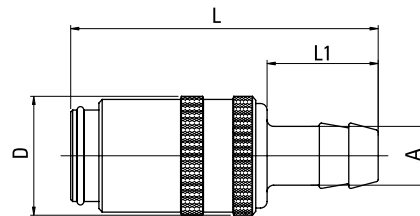

CODICE / Item no.

TL..SL

S	SERIES			A	D	L	L1	SW	VPE
6	65	TL6510-SL	TL6510OV-SL	10	18	60	22		10
9	90	TL9013-SL	TL9013OV-SL	13	24	71	25		10

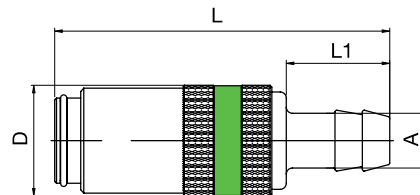

CODICE / Item no.

TV../90

S	SERIES			A	D	L	L1	SW	VPE
6	65	TV6510/90	TV6510/90OV	10	18	41	22		10
9	90	TV9013/90	TV9013/90OV	13	23	51	28,5		10
13	20	TV2019/90	TV2019/90OV	19	32	78	32		5

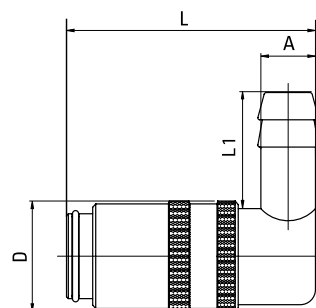

CODICE / Item no.

TV../90 SL

S	SERIES			A	D	L	L1	SW	VPE
6	65	TV6510/90-SL	TV6510/90OV-SL	10	18	53,5	22		10
9	90	TV9013/90-SL	TV9013/90OV-SL	13	24	63,5	28,5		10

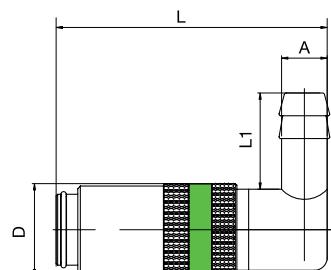

RACCORDI E INNESTI PER RAFFREDDAMENTO STANDARD EUROPEO

COUPLERS FOR MOULD COOLING EUROPEAN STANDARD

CODICE / Item no.

TV../45

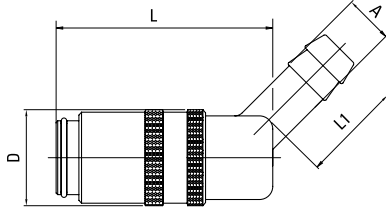

S	SERIES	↻	↔	A	D	L	L1	SW	VPE
6	65	TV6510/45	TV6510/45OV	10	18	52	22		10
9	90	TV9013/45	TV9013/45OV	13	23	51	25		10
13	20	TV2019/45	TV2019/45OV	19	32	78	30		5

CODICE / Item no.

TV../45 SL

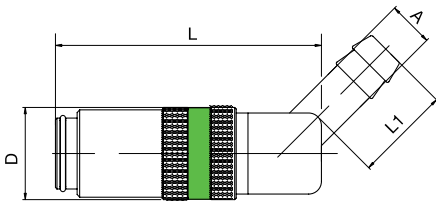

S	SERIES	↻	↔	A	D	L	L1	SW	VPE
6	65	TV6510/45-SL	TV6510/45OV-SL	10	18	60	22		10
9	90	TV9013/45-SL	TV9013/45OV-SL	13	24	60,5	25		10

CODICE / Item no.

TU..

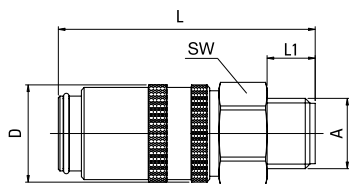

S	SERIES	↻	↔	A	D	L	L1	SW	VPE
6	65	TU65M14	TU65M14OV	M14x1,5	18	48	9	17	10
		TU651/4	TU651/4OV	G1/4	18	48	9	17	10
		TU653/8	TU653/8OV	G3/8	18	48	9	19	10
9	90	TU90M16	TU90M16OV	M16x1,5	23	51,5	9	22	10
		TU901/4	TU901/4OV	G1/4	23	51,5	9	22	10
		TU903/8	TU903/8OV	G3/8	23	51,5	9	22	10
		TU901/2	TU901/2OV	G1/2	23	54,4	12	22	10
13	20	TU20M24	TU20M24OV	M24x1,5	32	78	16	30	5
		TU201/2	TU201/2OV	G1/2	32	74	12	30	5
		TU203/4	TU203/4OV	G3/4	32	78	16	30	5

RACCORDI E INNESTI PER RAFFREDDAMENTO STANDARD EUROPEO

COUPLERS FOR MOULD COOLING EUROPEAN STANDARD

CODICE / Item no.

TU..SL

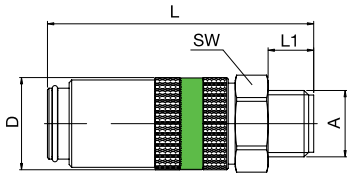

S	SERIES			A	D	L	L1	SW	VPE
6	65	TU65M14-SL	TU65M14OV-SL	M14x1,5	18	52,5	9	17	10
		TU651/4-SL	TU651/4OV-SL	G1/4	18	52,5	9	17	10
		TU653/8-SL	TU653/8OV-SL	G3/8	18	52,5	9	19	10
9	90	TU90M16-SL	TU90M16OV-SL	M16x1,5	24	62	9	22	10
		TU901/4-SL	TU901/4OV-SL	G1/4	24	62	9	22	10
		TU903/8-SL	TU903/8OV-SL	G3/8	24	62	9	22	10
		TU901/2-SL	TU901/2OV-SL	G1/2	24	65	12	22	10

CODICE / Item no.

TI..

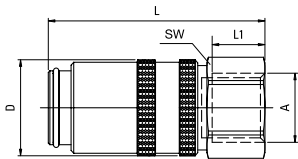

S	SERIES			A	D	L	L1	SW	VPE
6	65	TI615/4	TI651/4OV	G1/4	18	41	10	17	10
		TI653/8	TI653/8OV	G3/8	18	45	10	19	10
9	90	TI901/4	TI901/4OV	G1/4	23	46,5	10	21	10
		TI903/8	TI903/8OV	G3/8	23	46,5	10	21	10
		TI90M16	TI90M16OV	M16x1,5	23	46,5	10	21	10

CODICE / Item no.

TVU../90

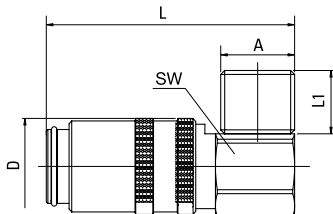

S	SERIES			A	D	L	L1	SW	VPE
6	65	TVU65M14/90	TVU65M14/90OV	M14x1,5	18	47	12	17	10
		TVU651/4/90	TVU651/4/90OV	G1/4	18	47	12	17	10
9	90	TVU90M16/90	TVU90M16/90OV	M16x1,5	23	53,5	12	22	10
13	20	TVU20M24/90	TVU20M24/90OV	M24x1,5	32	80	18	30	5

CODICE / Item no.

TVU../45

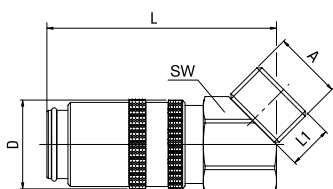

S	SERIES			A	D	L	L1	SW	VPE
6	65	TVU65M14/45	TVU65M14/45OV	M14x1,5	18	47	9	17	10
		TVU651/4/45	TVU651/4/45OV	G1/4	18	47	9	17	10
9	90	TVU90M16/45	TVU90M16/45OV	M16x1,5	23	53,5	9	22	10
13	20	TVU20M24/45	TVU20M24/45OV	M24x1,5	32	80	18	30	5

RACCORDI E INNESTI PER RAFFREDDAMENTO STANDARD EUROPEO

COUPLERS FOR MOULD COOLING EUROPEAN STANDARD

CODICE / Item no.

TS..

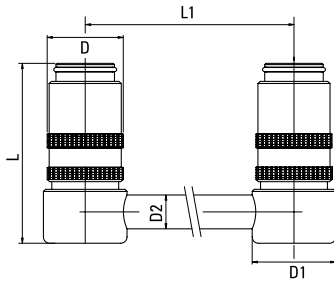

S	SERIES	↔	D	L	D1	D2	L1	VPE
6	65	TS65125	18	43	20	8	125	1
		TS65250	18	43	20	8	250	1
		TS65500	18	43	20	8	500	1
9	90	TS90125	23	53	26	10	125	1
		TS90250	23	53	26	10	250	1
		TS90500	23	53	26	10	500	1
13	20	TS20160	32	80	36	14	160	1
		TS20315	32	80	36	14	315	1
		TS20500	32	80	36	14	500	1

CODICE / Item no.

TN..

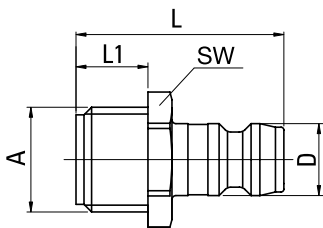

S	SERIES	↔	↔	A	D	L	L1	SW	VPE
6	65		TN65M8	M8x0,75	9	24	7	11	25
			TN65M10	M10x1	9	24	7	11	25
			TN651/8*	G1/8	9	24	7	11	25
			TN65M12	M12x1,5	9	27	10	14	25
			TN65M14	M14x1,5	9	26	9	15	25
			TN65M14V	M14x1,5	9	29	12	15	25
			TN651/4*	G1/4	9	26	9	15	25
			TN651/4V*	G1/4	9	29	12	15	25
			TN653/8*	G3/8	9	30	10	17	25
	90		TN901/8*	G1/8	13,5	25	8	14	25
9	90		TN90M14	M14x1,5	13,5	26	9	15	25
			TN901/4*	G1/4	13,5	26	9	15	25
			TN901/4V*	G1/4	13,5	31	12	15	25
			TN903/8*	G3/8	13,5	26	9	17	25
			TN903/8V*	G3/8	13,5	30	12	17	25
			TN90M16	M16z1,5	13,5	26	9	17	25
			TN90M16V	M16x1,5	13,5	30	12	17	25
13	20		TN20M24V	M24x1,5	19	51	16	27	10
			TN201/2*	G1/2	19	47	12	22	10
			TN203/4V*	TN203/4*	G3/4	19	51	16	27

* NICHELATO

* NICKEL PLATED

RACCORDI E INNESTI PER RAFFREDDAMENTO STANDARD EUROPEO

COUPLERS FOR MOULD COOLING EUROPEAN STANDARD

CODICE / Item no.

TN..INOX

S	SERIES	↔	A	D	L	L1	SW	VPE
6	65	TN65M8INOX	M8x0,75	9	24	7	11	25
		TN65M10INOX	M10x1	9	24	7	11	25
		TN651/8INOX	G1/8	9	24	7	11	25
		TN651/4INOX	G1/4	9	26	9	15	25
9	90	TN901/4INOX	G1/4	13,5	26	9	15	25
		TN903/8INOX	G3/8	13,5	26	9	17	25

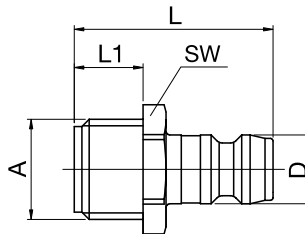

CODICE / Item no.

TN..100

S	SERIES	↔	A	D	L	L1	SW	VPE
6	65	TN651/8/100	G1/8	9	100	60	11	10
		TN651/4/100	G1/4	9	100	60	14	10
9	90	TN901/4/100	G1/4	13,5	100	60	14	10
		TN903/8/100	G3/8	13,5	100	60	19	10

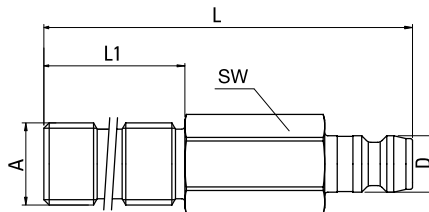

CODICE / Item no.

TN..

S	SERIES	↔	A	D	L	L1	SW	VPE
6	65	TN6508/63	8	9	63	42	9	10
		TN6508/100	8	9	100	79	9	10
		TN6510/120	10	9	120	100	11	10
		TN6510/240	10	9	240	220	11	10
9	90	TN6510/360	10	9	360	340	11	10
		TN9014/150	14	13,5	150	125	15	10
		TN9014/300	14	13,5	300	275	15	10
13	20	TN9014/450	14	13,5	450	425	15	10
		TN2021/500	21	19	500	465	22	5
		TN2021/800	21	19	800	765	22	5

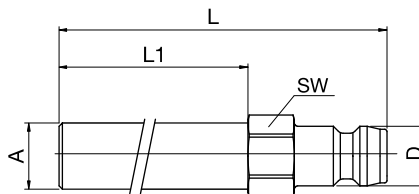

RACCORDI E INNESTI PER RAFFREDDAMENTO STANDARD EUROPEO

COUPLERS FOR MOULD COOLING EUROPEAN STANDARD

CODICE / Item no.

TNV..

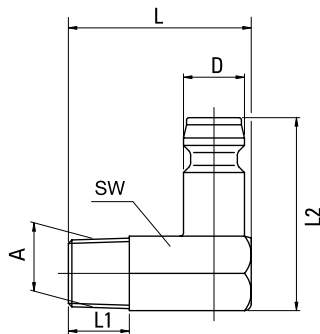

S	SERIES	↔	A	D	L	L1	L2	SW	VPE
6	65	TNV65M8	M8x0,75	9	27	9	28,5	11	25
		TNV65M10	M10x1	9	27	9	28,5	11	25
		TNV651/8*	R1/8	9	27	9	28,5	11	25
9	90	TNV651/4*	R1/4	9	27	9	28,5	11	25
		TNV90M14	M14x1,5	13,5	34	11	32	15	25
		TNV901/4*	R1/4	13,5	34	11	32	15	25
13	20	TNV903/8*	R3/8	13,5	34	11	32	15	25
		TNV20M24	M24x1,5	19	47	16	54	24	5
		TNV201/2*	R1/2	19	47	16	54	24	5

* NICHELATO
* NICKEL PLATED

CODICE / Item no.

TN..

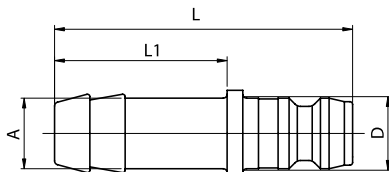

S	SERIES	↔	A	D	L	L1	VPE
6	65	TN6510	10	9	38	22	25
9	90	TN9010	10	13,5	41	25	25
		TN9013	13	13,5	41	25	25
13	20	TN2013	13	19	61	32	5
		TN2019	19	19	61	32	5

CODICE / Item no.

TNI..

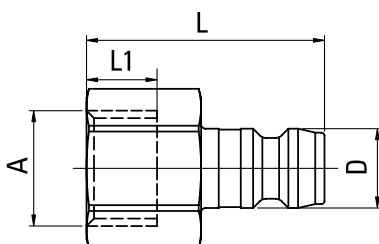

S	SERIES	↔	A	D	L	L1	SW	VPE
6	65	TNI651/8	G1/8	9	24	7	11	25
		TNI651/4	G1/4	9	27	8	16	25
9	90	TNI901/4	G1/4	13,5	33	8	16	25