

# RONDELLA PER COLONNA CEA

WASHER FOR PILLAR CEA

CODICE / Item no.

# RTI

Materiale: 1.7131  
Material: 1.7131

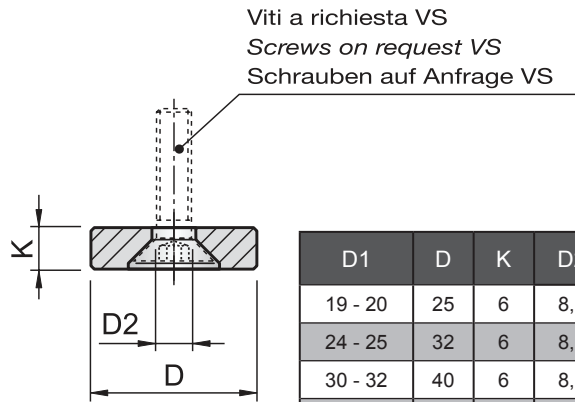
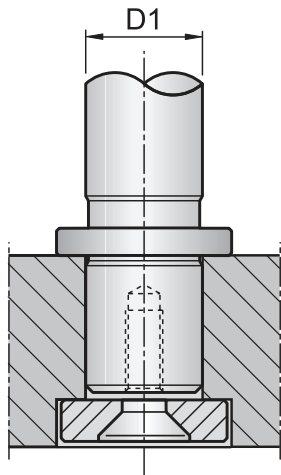

D1	D	K	D2
19 - 20	25	6	8,5
24 - 25	32	6	8,5
30 - 32	40	6	8,5
38 - 40	50	6	8,5
48 - 50	60	6	8,5
60 - 63	70	6	8,5
80	93	12	12,5

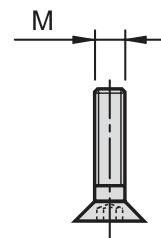

**VS**

M
M 8 x 20
M 10 x 20
M 12 x 30

ESEMPIO DI ORDINAZIONE VS M  
ORDERING EXAMPLE VS M

ESEMPIO DI ORDINAZIONE RTI D  
ORDERING EXAMPLE RTI D

# STAFFETTE DI RITEGNO

RETAINING CLAMPS

CODICE / Item no.

# S

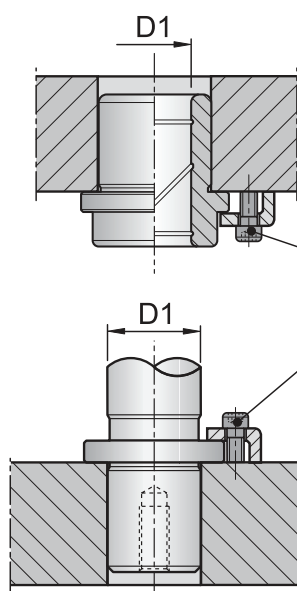

S 6 ISO

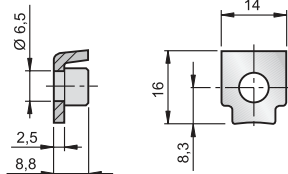

S 23 ISO

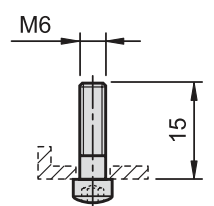
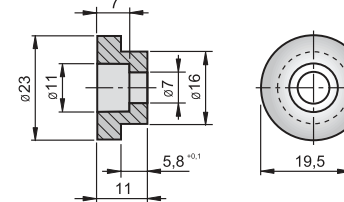

S 8 ISO

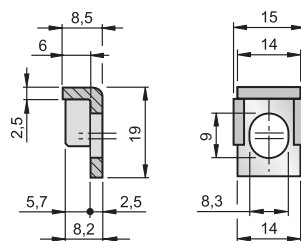

S 8 P ISO

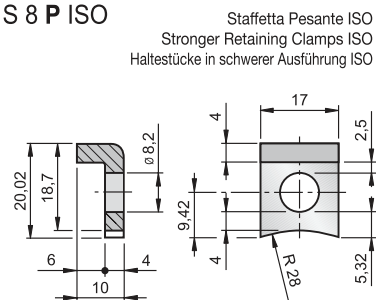

Staffetta Pesante ISO  
Stronger Retaining Clamps ISO  
Haltestücke in schwerer Ausführung ISO

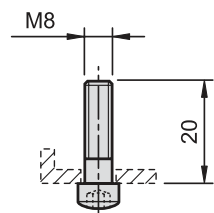

Viti a richiesta / Screws on request / Schrauben auf Anfrage

ESEMPIO DI ORDINAZIONE V M  
ORDERING EXAMPLE V M

**V**

M
M 6 x 15
M 8 x 20